

Configuration for version 1.x 690+.

<b>Important!</b> Configurations display configurable connections and parameters only.	DWN		SIZE	DWG. NO.
	CHK		D:\CELITE\New_2.690	
	APP		ISSUE	1
			SCALE	SHEET 1 OF 6

# Menus

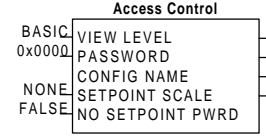
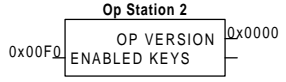
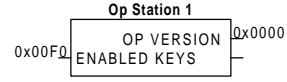
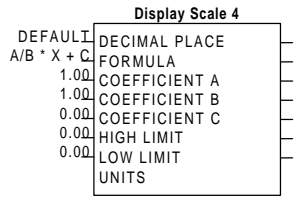
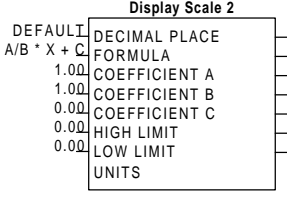
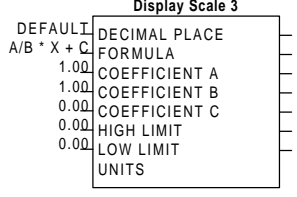
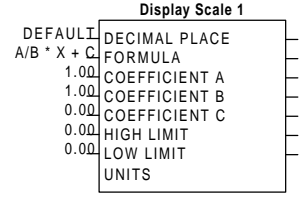
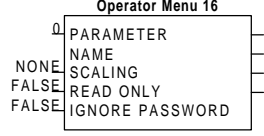
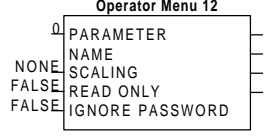
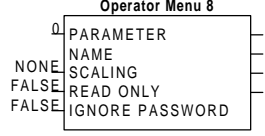
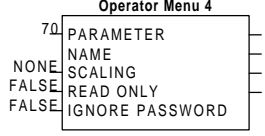
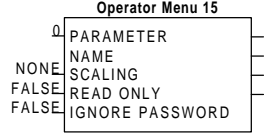
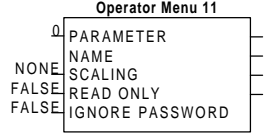
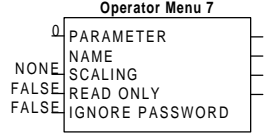
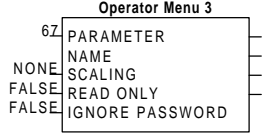
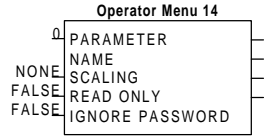
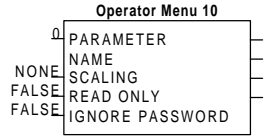
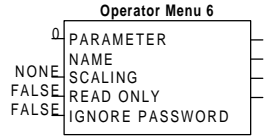
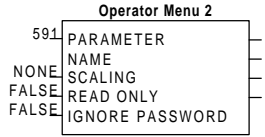
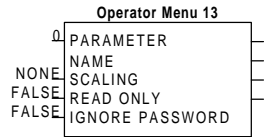
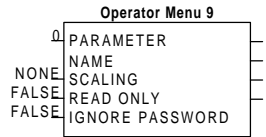
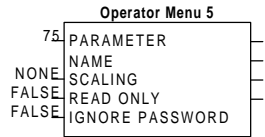
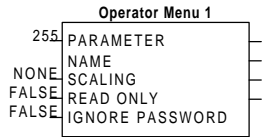

Configuration for version 1.x 690+.

<b>Important!</b> Configurations display configurable connections and parameters only.	DWN			SIZE	DWG. NO.
	CHK		D:\ICELITE\New_2.690	ISSUE	1
	APP			SCALE	SHEET 2 OF 6

## Motor Control

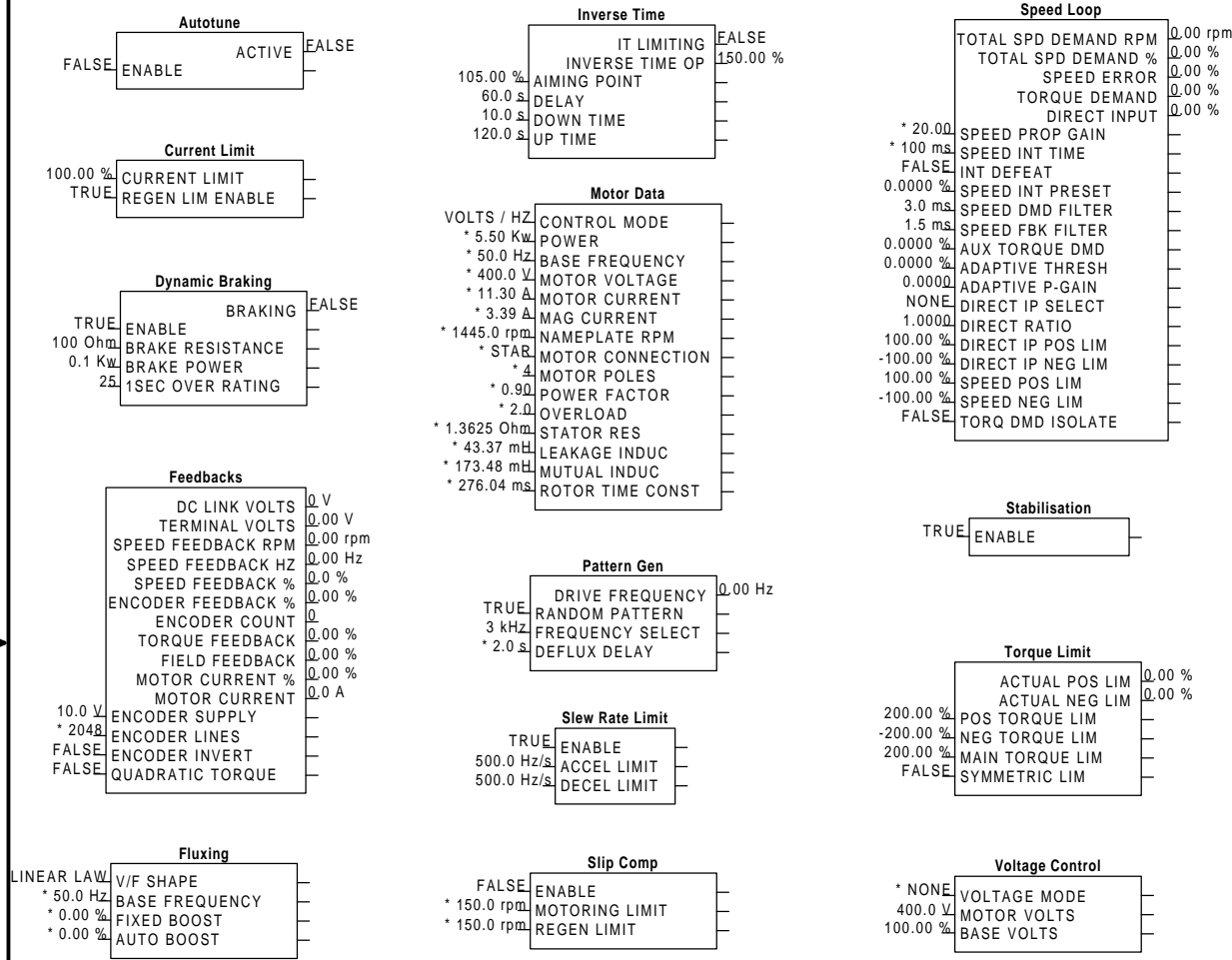

## Sequencing and Reference

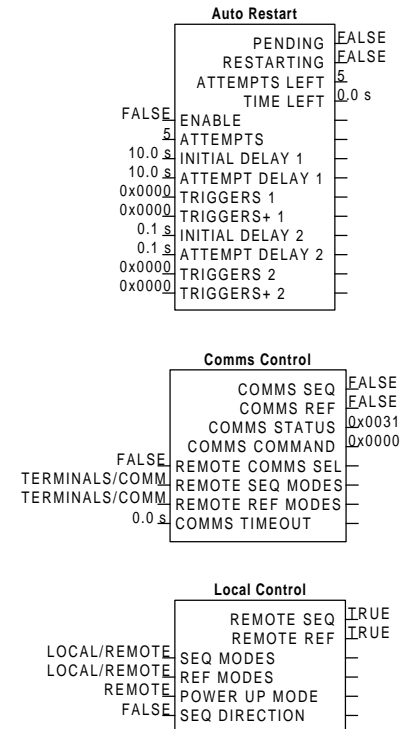

## Communications

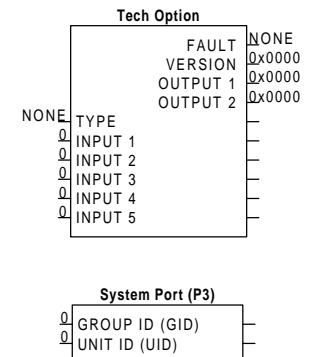

Configuration for version 1.x 690+.

<b>Important!</b> Configurations display configurable connections and parameters only.	DWN		SIZE	DWG. NO.
	CHK		D:\ICELITE\New_2.690	ISSUE 1
	APP		SCALE	SHEET 3 OF 6

# Setpoint Functions

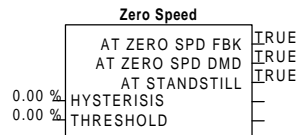
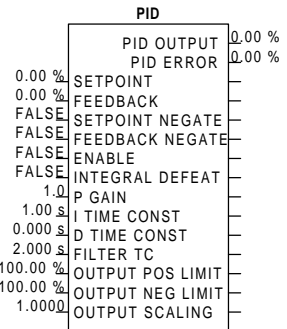
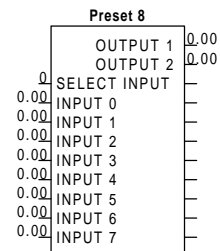
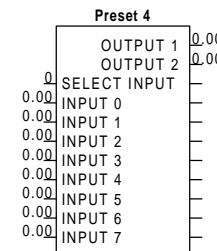
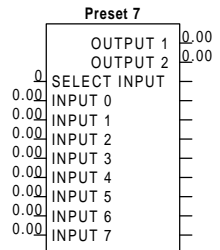
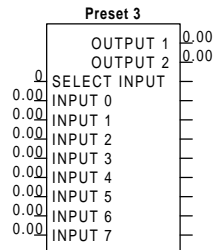
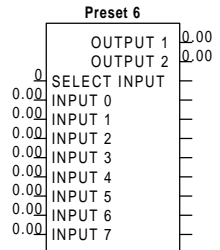
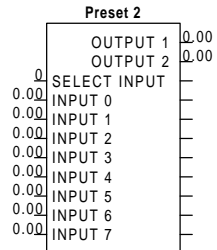
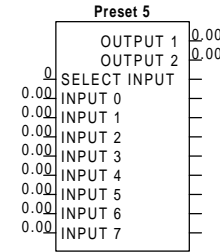
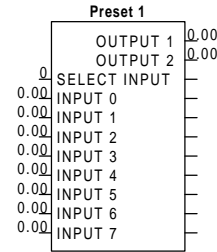
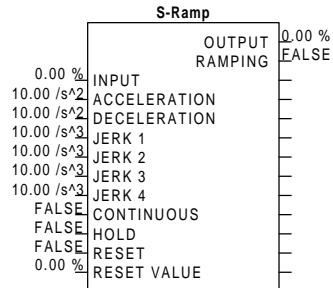
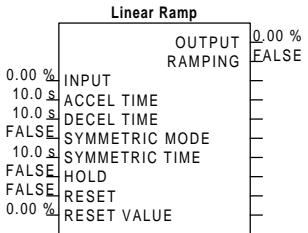
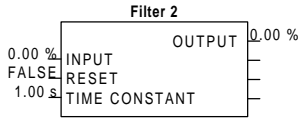
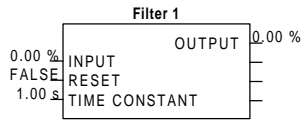

# Trips

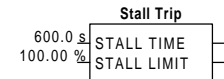
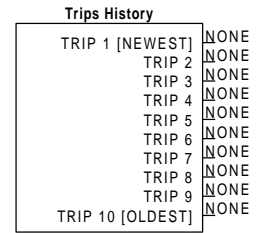

# Hoist/Lift

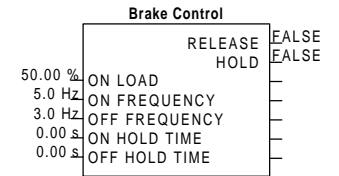

Configuration for version 1.x 690+.

<b>Important!</b> Configurations display configurable connections and parameters only.	DWN		SIZE A	DWG. NO.
	CHK		D:\CELITE\New_2.690	
	APP		ISSUE 1	SCALE
			SHEET	4 OF 6

# Winder

Compensation	
COMPENSATIONS	0.00 %
INERTIA COMP	0.00 %
SCALED RATE	0.00 %
LINE SPEED RATE	0.00 %
DIAMETER	10.00 %
MINIMUM DIAMETER	10.00 %
VARIABLE INERTIA	0.00 %
FIXED INERTIA	0.00 %
WIDTH	0.00 %
UNWIND	FALSE
LINE SPD DEMAND	0.00 %
RATE CAL	0.00 %
REVERSE	FALSE
DYNAMIC COMP	0.00 %
STATIC COMP	0.00 %
MOD WINDER SPEED	0.00 %

Diameter Calc	
CURRENT CORE	10.00 %
DIAMETER	10.00 %
MOD LINE SPEED	0.00 %
MOD WINDER SPEED	0.00 %
DIAMETER HOLD	FALSE
PRESET ENABLE	FALSE
SELECT CORE 2	FALSE
SEL EXT DIAMETER	FALSE
TENSION ENABLE	FALSE
CORE 1	10.00 %
CORE 2	10.00 %
DIAMETER TC	5.00 %
EXT DIAMETER	0.00 %
LINE SPEED	0.00 %
MINIMUM DIAMETER	10.00 %
MINIMUM SPEED	5.00 %
WINDER SPEED	0.00 %

Speed Calc	
SPEED DEMAND	0.00 %
UP TO SPD (UTS)	TRUE
UNWIND	FALSE
OVER-WIND	FALSE
OVER SPD ENABLE	FALSE
UTS THRESHOLD	5.00 %
LINE SPEED	0.00 %
MOD WINDER SPEED	0.00 %
DIAMETER	10.00 %
MINIMUM DIAMETER	10.00 %
OVER SPEED	0.00 %
SPEED TRIM	0.00 %

Taper Calc	
TAPERED DEMAND	0.00 %
TENSION DEMAND	0.00 %
HYPERBOLIC TAPER	FALSE
STALL ENABLE	FALSE
BOOST ENABLE	FALSE
FIXED BOOST	FALSE
FIXED STALL TENSION	FALSE
CURRENT CORE	0.00 %
DIAMETER	10.00 %
BOOST	0.00 %
TENSION RAMP	1.000 s
STALL TENSION	0.00 %
TAPER SPT	0.00 %
TENSION SPT	0.00 %

Torque Calc	
POS TORQUE LIMIT	200.00 %
NEG TORQUE LIMIT	-200.00 %
OVER-WIND	FALSE
TENSION ENABLE	FALSE
TENSION DEMAND	0.00 %
TORQUE LIMIT	200.00 %

Configuration for version 1.x 690+.

<b>Important!</b> Configurations display configurable connections and parameters only.	DWN		SIZE A	DWG. NO.
	CHK		D:\CELITE\New_2.690	ISSUE 1
	APP		SCALE	SHEET 5 OF 6

# Miscellaneous

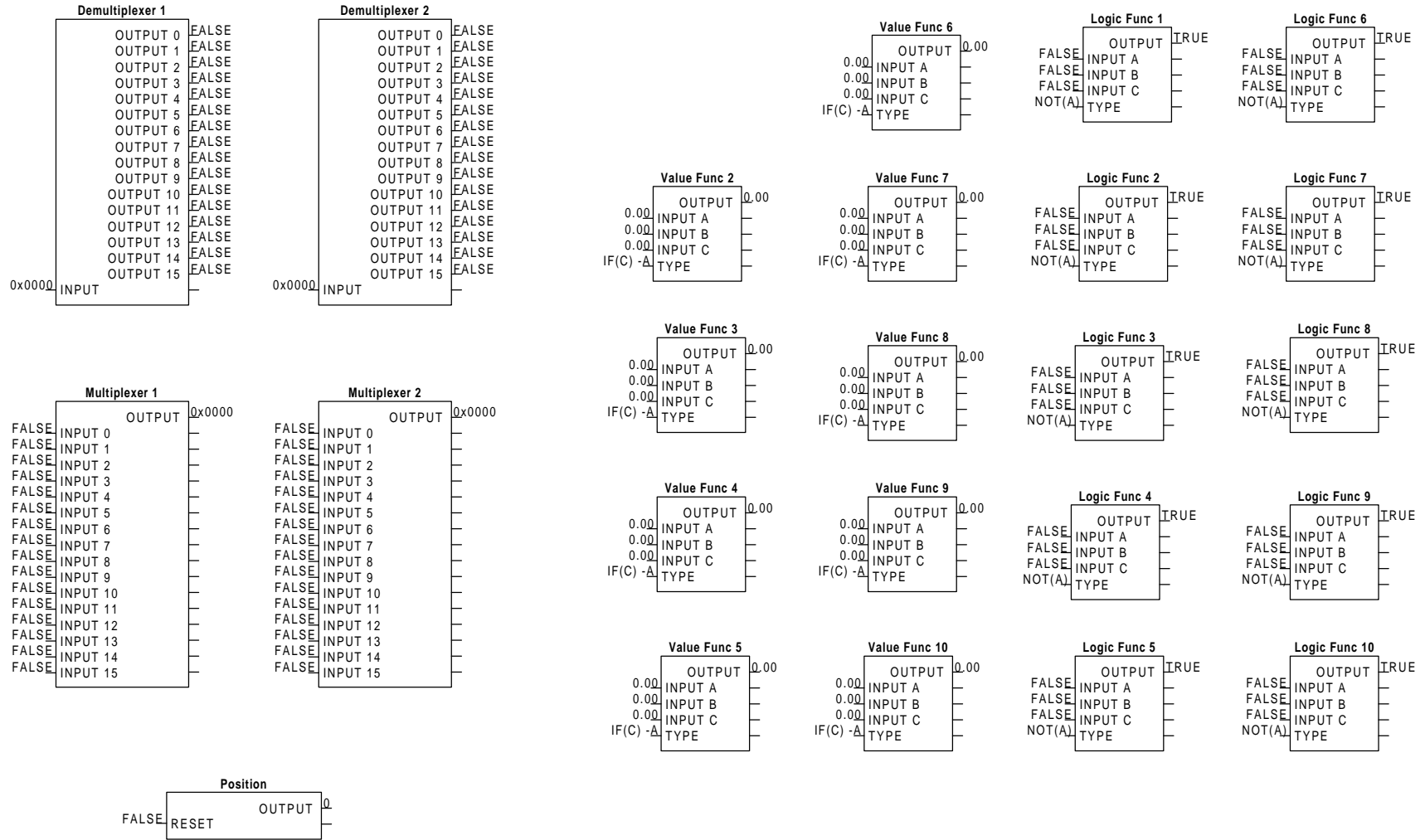

Configuration for version 1.x 690+.

<b>Important!</b> Configurations display configurable connections and parameters only.	DWN		SIZE A	DWG. NO.
	CHK		D:\CELITE\New_2.690	ISSUE 1
	APP		SCALE	SHEET 6 OF 6